

Transfer Switches/ Power Inlets

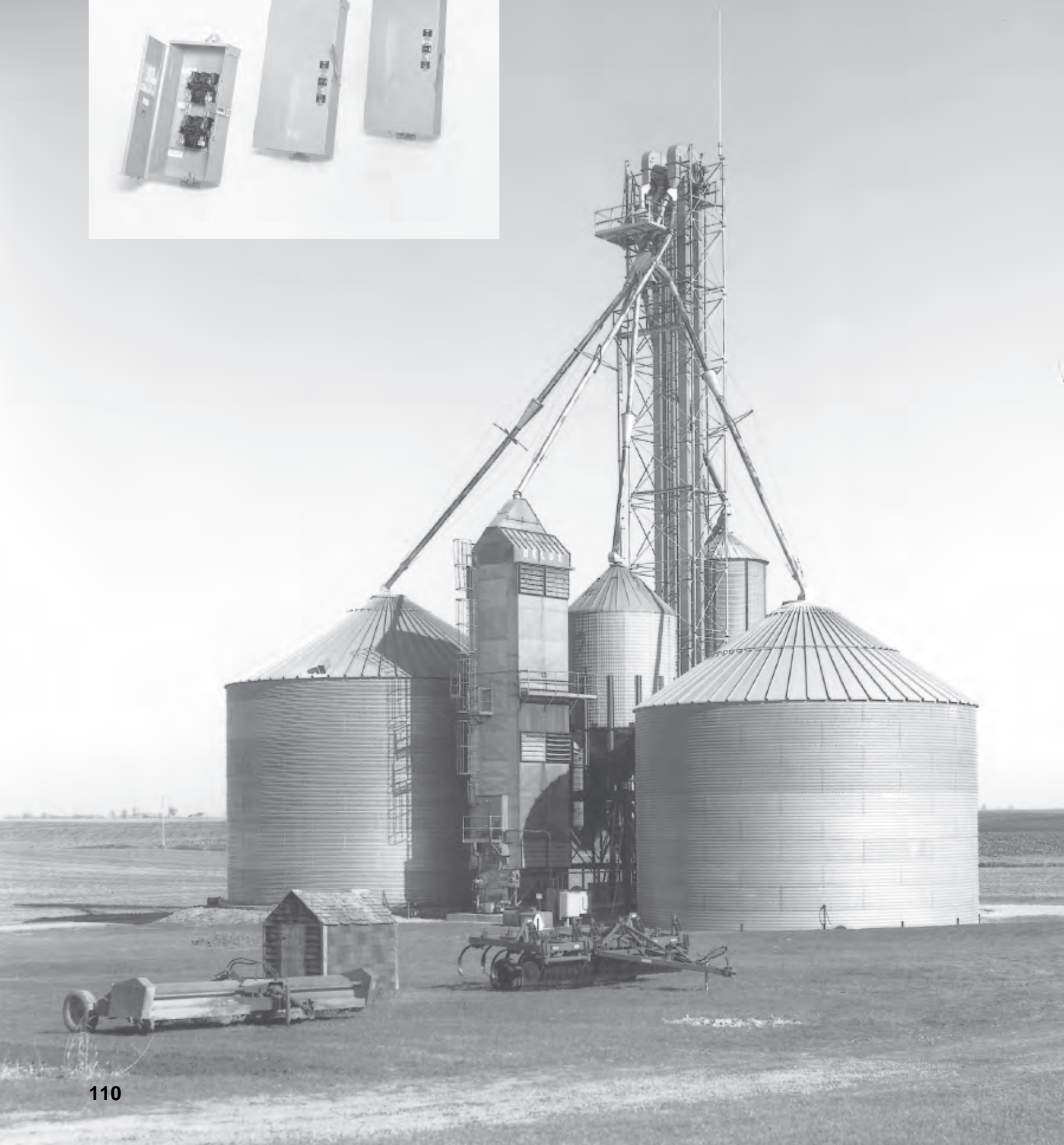

Application Information

The Midwest Heavy Duty manual transfer switch provides reliable, trouble-free transfer of power from the normal utility supplied source, to a stand-by generator. This enables the user to maintain power during utility down time periods. The “double throw” mechanism helps prevent dangerous backfeeding of generator power into the utility system. The Midwest transfer switch is designed to be fully operational and switchable at full rated capacity.

The Midwest Transfer switch is available in single phase and three phase configurations, and in ratings through 600V. Special application models, with meter sockets or switched neutrals, are also available.

Typical applications include poultry farms, dairy farms, ventilation in animal confinement buildings, crop drying, and anywhere an extended loss of normal power service would result in severe loss, damage or inconvenience.

Features and Benefits

Electrical Ratings

- 100-400 amperes
- 240 and 600 volt maximum models available
- 10,000 AIC

Rugged Durability

- Quick-Make, Quick-Break switch mechanism on most models
- All-In-One Construction for factory assured terminations
- Bus bars used to interconnect main and standby switches on most models
- Knife blade switch contacts provide long life
- Heavy zinc coated steel with highest quality powder coat finish resists corrosion and fading
- Welded flange, NEMA 3R construction, for lasting service in outdoor installations
- Quality user tested components for long life
- Non-metered models UL Listed, “Suitable for use as service equipment, when installed in accordance with the NEC.”

User Safety

- Interlock allows door opening only when switch is in the off position
- Padlock provision in all three on-off-on transfer positions
- Door has padlock provision

Installation Ease

- Optional neutral kit available for both 240-volt and 600-volt
- Broad range of concentric knockouts to accommodate varied wiring needs
- All terminals accept copper or aluminum wire for added installation flexibility



Single Phase

Fig. A

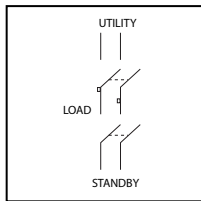

Single Phase- Switched Neutral

Fig. B

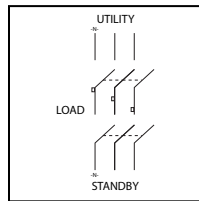

Three Phase

Fig. C

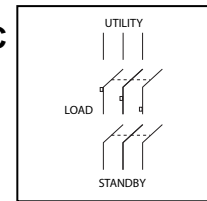

Single Phase 120/240 Volts AC

FIG.	UL	MODEL NUMBER	AMPS		VOLTS	PHASE	WIRE RANGE (CuAl)	HUB* (included)	UNIT WGT.	STD. PKG.	NEUTRAL KITS (FIELD INSTALLED ONLY) ORDER MODEL #
			MAIN	STANDBY							
A	Y	GS1101B12UL	100	100	120/240	1	12-1/0	1 1/4"	31	1	NEU102
A	Y	GS3161G**	100	100	120/240	1	12-1/0	Order Separately	11	1	INSTALLED
A	Y	GS1201B20UL	200	100	120/240	1	6-250	2"	42	1	NEU202
A	Y	GS1202B20UL	200	200	120/240	1	6-250	2"	46	1	NEU202
A	Y	GS1402B01UL	400	200	120/240	1	2-600 or (2) 1/0-250	Order Separately	71	1	NEU407
A	Y	GS1404B01UL	400	400	120/240	1	2-600 or (2) 1/0-250	Order Separately	80	1	NEU407

** Light Duty Transfer Switches

Single Phase 120/240 Volts AC with Attached Meter Socket*

FIG.	UL	MODEL NUMBER	AMPS		VOLTS	PHASE	WIRE RANGE (CuAl)	HUB* (included)	UNIT WGT.	STD. PKG.	NEUTRAL
			MAIN	STANDBY							
A		GS1202B20M	200	200	120/240	1	6-250	2"	50	1	INSTALLED

* Metered unit not UL listed – Does not meet NEC Code

Single Phase 120/240 Volts AC - Switch Neutral

FIG.	UL	MODEL NUMBER	AMPS		VOLTS	PHASE	WIRE RANGE (CuAl)	HUB* (included)	UNIT WGT.	STD. PKG.	NEUTRAL KITS (FIELD INSTALLED ONLY) ORDER MODEL #
			MAIN	STANDBY							
B	Y	GS3161B12UL	100	100	120/240	1	12-1/0	1 1/4"	31	1	Factory Installed
B	Y	GS3262B25UL	200	200	120/240	1	6-250	2 1/2"	48	1	Factory Installed
B	Y	GS3464B01UL	400	400	120/240	1	2-600 or (2) 1/0-250	Order Separately	120	1	Factory Installed

Three Phase 240, 120/240 Volts AC

FIG.	UL	MODEL NUMBER	AMPS		VOLTS	PHASE	WIRE RANGE (CuAl)	HUB* (included)	UNIT WGT.	STD. PKG.	NEUTRAL KITS (FIELD INSTALLED ONLY) ORDER MODEL #
			MAIN	STANDBY							
C	Y	GS3262G**	200	200	240	3	6-250	Order Separately	43	1	INSTALLED
C	Y	GS3402B01UL	400	200	240	3	2-600 or (2) 1/0-250	Order Separately	107	1	NEU407
C	Y	GS3404B01UL	400	400	240	3	2-600 or (2) 1/0-250	Order Separately	120	1	NEU407

** Light Duty Transfer Switches

Three Phase 600 Volt AC

FIG.	UL	MODEL NUMBER	AMPS		VOLTS	PHASE	WIRE RANGE (CuAl)	HUB* (included)	UNIT WGT.	STD. PKG.	NEUTRAL KITS (FIELD INSTALLED ONLY) ORDER MODEL #
			MAIN	STANDBY							
C	Y	GS3161B12UL	100	100	600	3	12-1/0	1 1/4"	31	1	NEU102
C	Y	GS3262B25UL	200	200	600	3	6-250	2 1/2"	48	1	NEU202
C	Y	GS3464B01UL	400	400	600	3	2-600 or (2) 1/0-250	Order Separately	120	1	NEU407

* For Hub Model Number see Table on page 122

Transfer Switches Technical Data



MODEL NUMBER	CABINET SIZE	ENCLOSURE STYLE	CABINET DIMENSIONS				KNOCKOUT FIGURE
			HEIGHT	WIDTH	DEPTH	DEPTH	
			A	B	C	D	
GS1101B12UL	26 x 13 x 6	A	26"	13"	6-3/4"	10-5/8"	1
GS1201B20UL	32 x 15 x 6	A	32"	15-3/4"	6-3/4"	10-5/8"	2
GS1202B20M	38 x 15 x 6	B	38-1/4"	15-3/4"	6"	10-5/8"	2
GS1202B20UL	35 x 15 x 7	A	35"	15-3/4"	7"	10-5/8"	2
GS1402B01UL	43 x 18 x 9	A	43-1/2"	18-1/2"	9-1/4"	14-1/8"	3
GS1404B01UL	43 x 18 x 9	A	43-3/4"	18-1/2"	9-1/4"	14-1/8"	3
GS3161B12UL	26 x 13 x 6	A	26"	13"	6-3/4"	10-5/8"	1
GS3161G	15 x 9 x 7	A	15-3/4"	9-3/4"	7"	6-1/2"	5
GS3262B25UL	34 x 15 x 6	A	34-3/4"	15-3/4"	6-3/4"	10-5/8"	2
GS3262G	30 x 17 x 10	A	30-1/2"	17"	10"	12"	6
GS3402B01UL	42 x 24 x 9	A	42-1/2"	24"	9-1/4"	14-1/8"	4
GS3404B01UL	43 x 24 x 9	A	43-1/2"	24"	9"	14-1/8"	4
GS3464B01UL	43 x 24 x 9	A	43-1/2"	24"	9"	14-1/8"	4

Neutral Kits

MODEL NUMBER	UNIT WGT. LBS.	WIRE RANGE
NEU102	1	(5) 12-1/0
NEU202	1	(2) 14-1/0, (3) 6-250
NEU407	2	(2) 14-1/0, (3) 2-600

Cabinet Dimensions

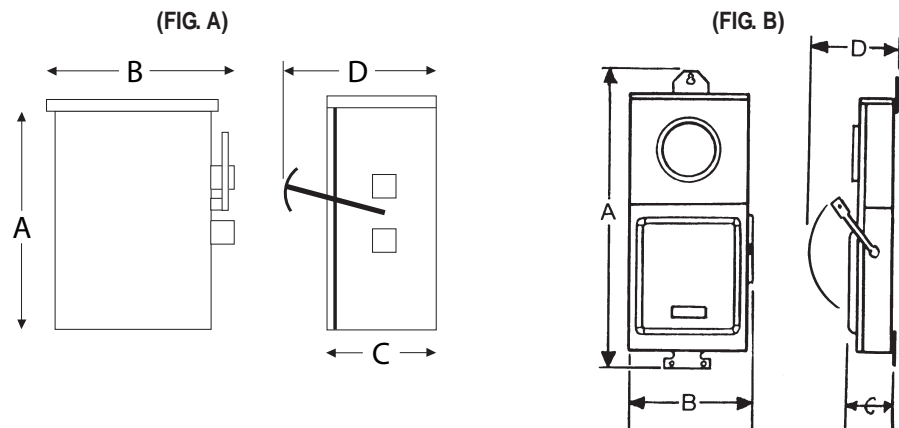

Knockout Configurations

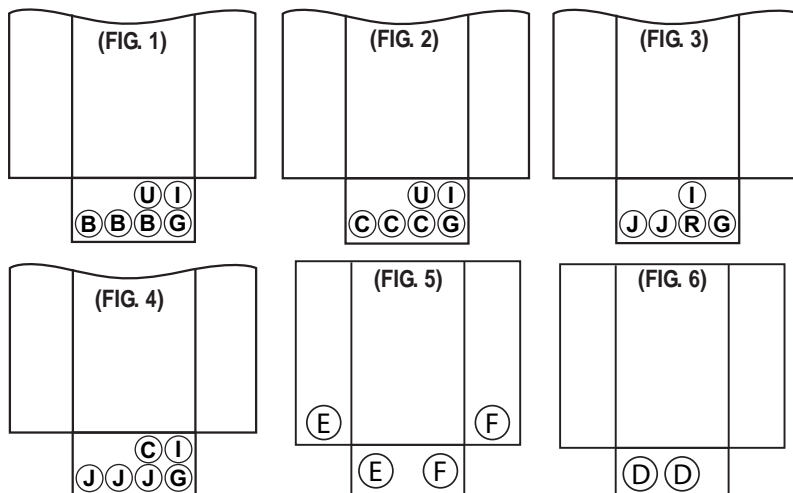

- B = 1", 1-1/4", 1-1/2"
- C = 1-1/4", 1-1/2", 2"
- D = 2", 2-1/2", 3"
- E = 1", 1-1/4", 1-3/4"
- F = 1-1/4", 1-3/4", 2"
- G = 1/2", 3/4", 1"
- I = 11/16"
- J = 2", 2-1/2", 3", 3-1/2"
- R = 3/4", 1", 1-1/4", 1-1/2", 2"
- U = 1/4"

Data subject to change without notice.

Transfer Switches

Features and Benefits

Save Costly Installation Time

- G90 Galvanized steel with superior electro-deposition paint finish provides excellent corrosion protection
- All in one construction for factory assured terminations
- Rolled edge door for cord protection
- Cover design allows cords to exist while maintaining the NEMA 3R integrity
- Padlockable door to help prevent unauthorized access
- Deadfront construction prevents accidental contact with live parts
- UL listed

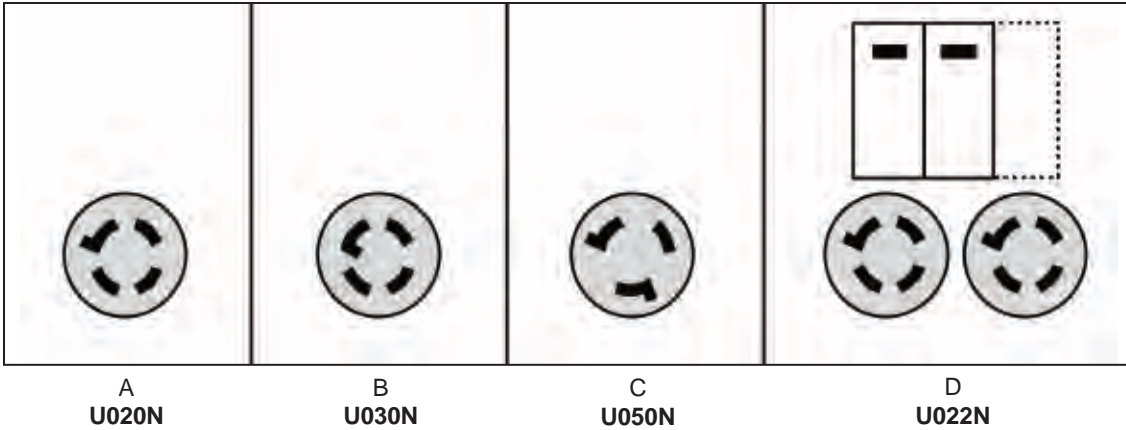
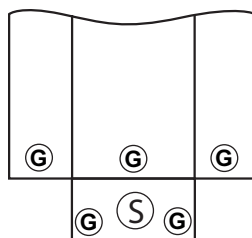

FIG.	UL	MODEL NUMBER	RECEPTACLES	AMPS	VOLTS	HEIGHT	WITDTH	DEPTH
A	Y	U020N	L14-20	20	120/240	14-3/8"	6-3/4"	5-3/16"
B	Y	U030N	L14-30	30	120/240	14-3/8"	6-3/4"	5-3/16"
C	Y	U050N	CS6375 **	50	120/240	14-3/8"	6-3/4"	5-3/16"
D	Y	U022N	(2) L14-20 *	40	120/240	14-3/8"	6-3/4"	5-3/16"

* U022N also has (2) CB120 circuit breakers and one breaker space.

** CS6375 is a California Standard, 3-pole / 4-wire grounded non-NEMA.

Knockouts



G = 1/2", 3/4", 1"

S = 1/2", 3/4", 1", 1-1/4", 1-1/2"

Application Information

The Midwest Ranch Panel provides a reliable and convenient solution for meter socket and maximum circuit layout flexibility.

Designed and manufactured to meet EUSERC standards, these high quality NEMA 3R meter centers are a superior solution to a wide range of specific applications. Increased durability and flexibility, combined with ease of installation, add up to lower installed cost.

Features and Benefits

Electrical Ratings

- 200 Main Amp Rating
- UL Listed
- Feed through lugs
- 120-240V, Single-Phase
- 3-wire

Enclosure

- CB4200H circuit breaker installed
- NEMA 3R enclosure
- Suitable for surface mounting
- Wide box with generous wire bend space for inside feed of overhead or underground applications
- Removable side-opening door
- 3" concentric knockouts

Breaker Panel

- Space for parallel secondary disconnect
- Series rated 22kAIC main breaker
- Factory installed bonded neutral
- Combination slotted/Roberson neutral screws
- Minimum 100% neutral terminations
- Room for two neutral wires per hole
- Solid, extra long neutral bar
- Accepts 1" or 1/2" circuit breakers - total of 8 single-pole or 4 double-pole provisions.



Surface - Metered

Model Number	Main AMP Rating	Maximum Spaces				Total 1-Pole Spaces	Type of Feed
		1" Breaker		1/2" Breaker			
		1-Pole	2-Pole	1-Pole	2-Pole		
MS2453C	200	4	2	8	3	8	Overhead/Underground

Ranch Panel